

1. UNIVERSAL RIDGE CAP

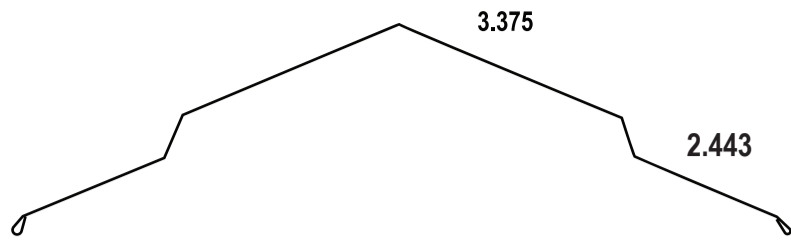

2. MINI CORNER

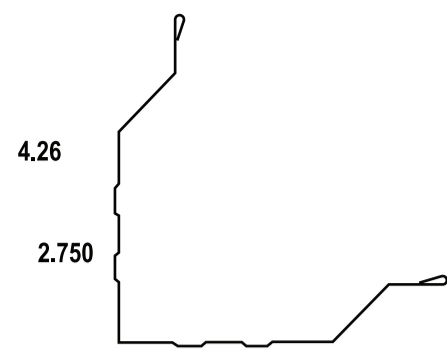

3. RAKE & CORNER



4. DRIP EDGE

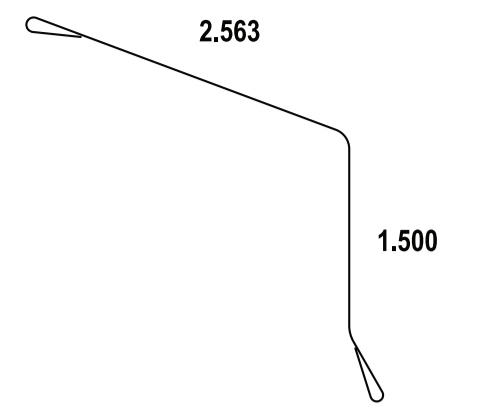

5. SNOW RAIL

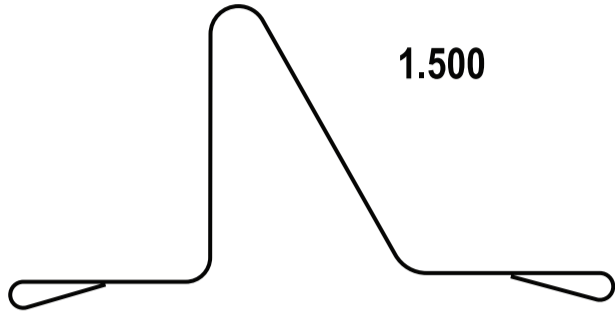

6. SPLASH GUARD

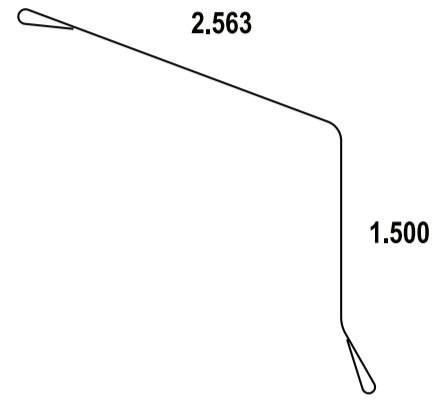

7. DENVER EAVE

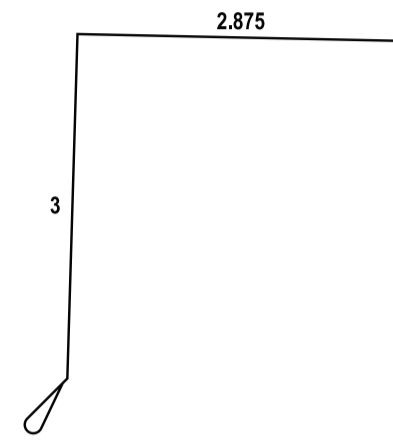

8. ENDWALL FLASHING

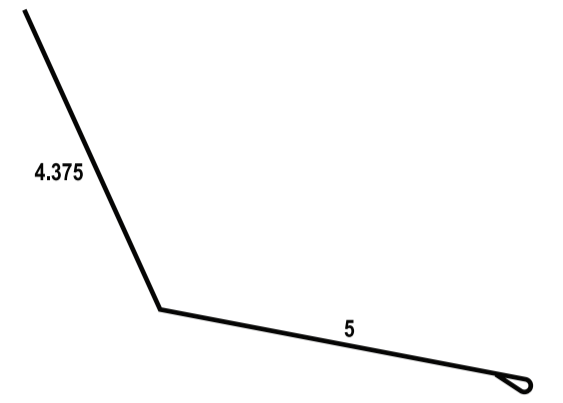

9. SIDEWALL FLASHING

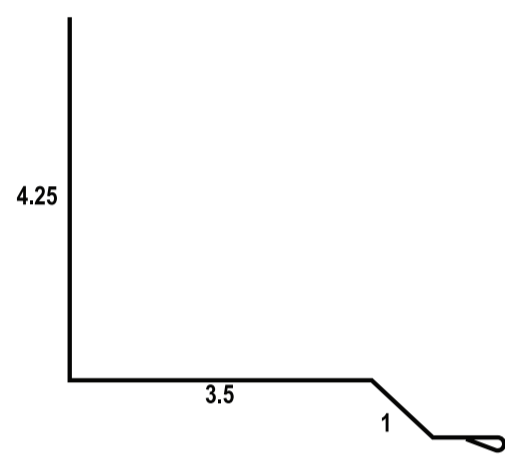

10. TRANSITION FLASHING

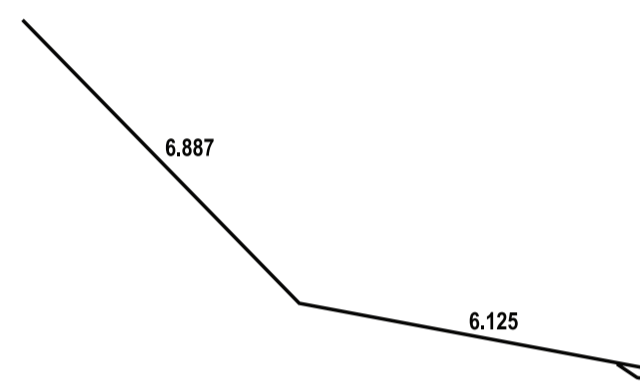

11. GAMBREL TRIM

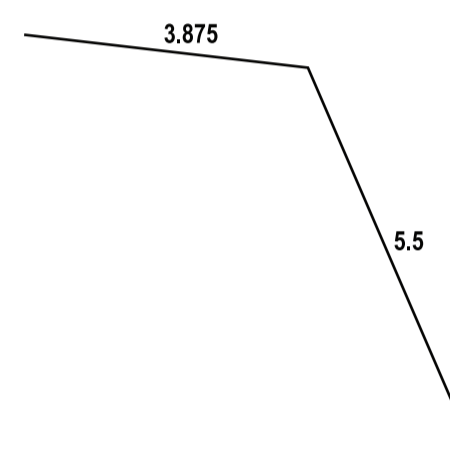

12. VALLEY

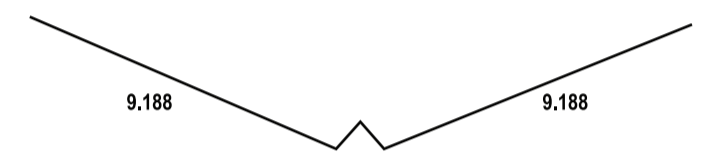

13. CHIMNEY FLASHING

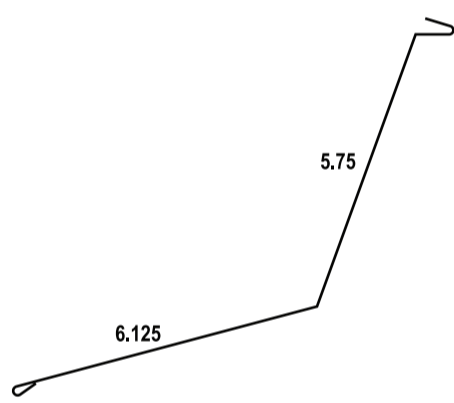

14. BASE ANGLE

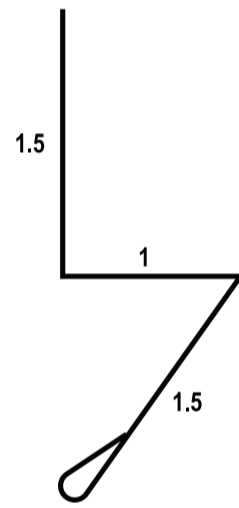

15. DOUBLE ANGLE

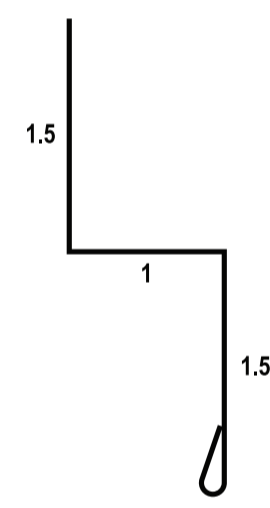

16. DRIP CAP

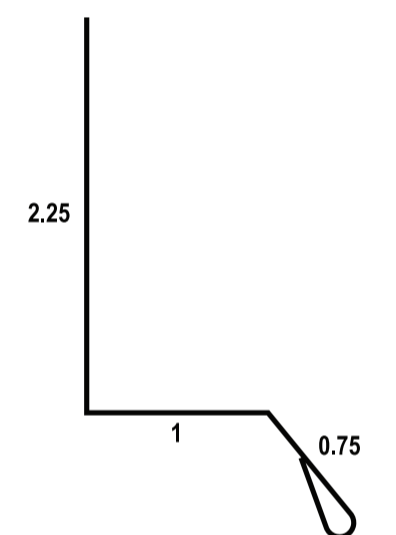

17. F&J CHANNEL

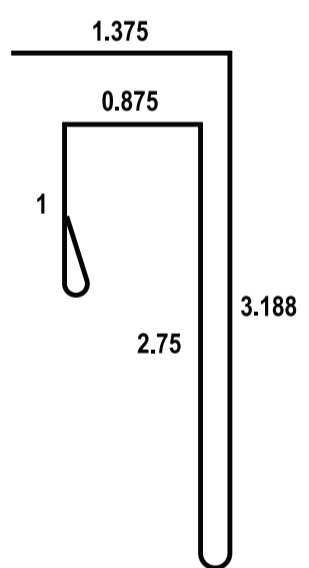

18. C&T CHANNEL

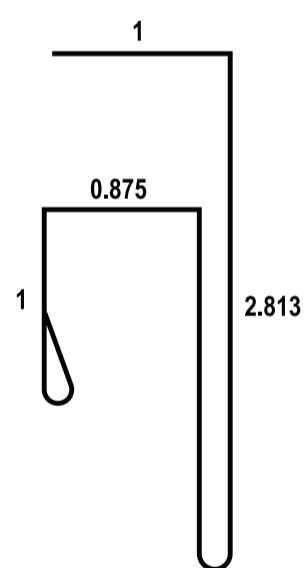

19. J CHANNEL

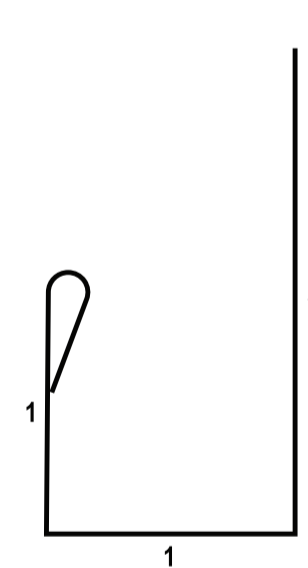

20. 1.5" ANGLE

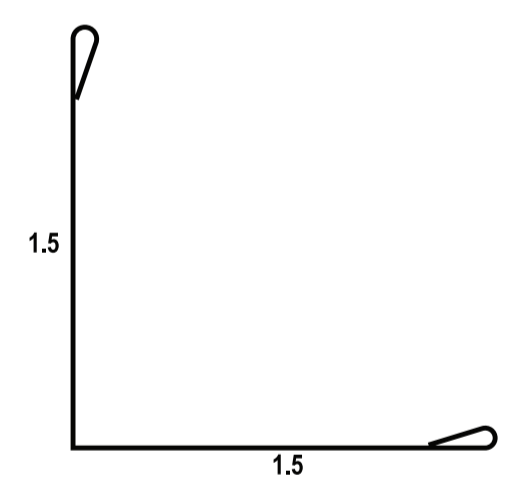

21. OVERHEAD DOOR TRIM



22. FASCIA

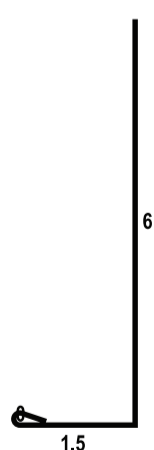

23. INTERIOR BASE ANGLE

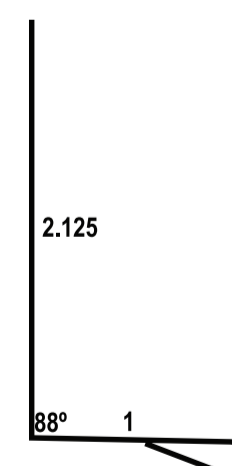

24. TRACK COVER

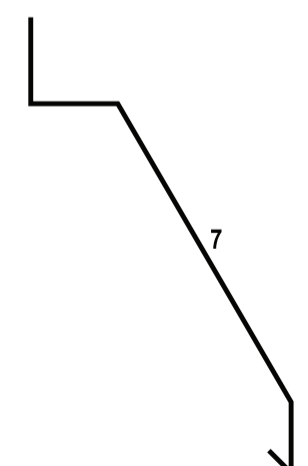

25. INSIDE CORNER

